

INSTRUCCIONES DE ENSAMBLE

Encuétranos en: www.practimac.com y [YouTube/practimac](https://www.youtube.com/practimac)

BIBLIOTECA AMATISTA P00374BI-ROBL -P00374BI-WE

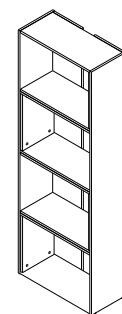
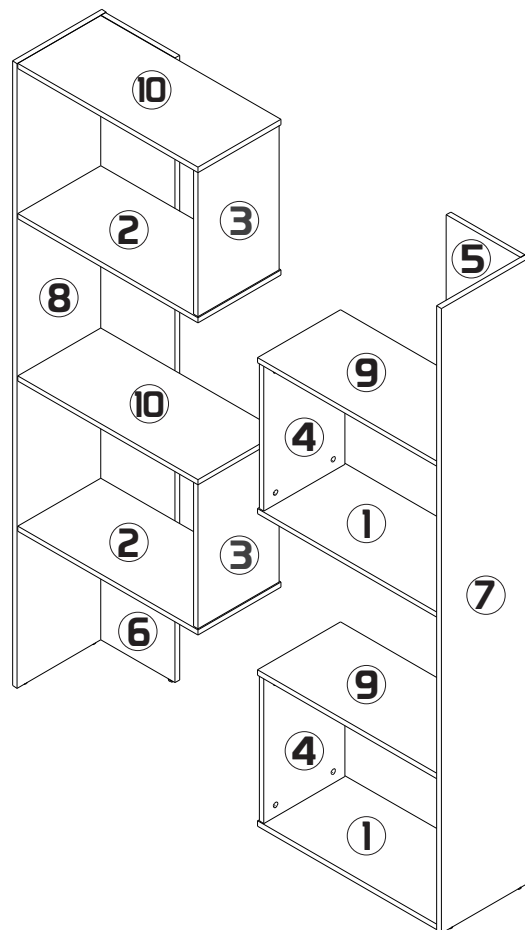
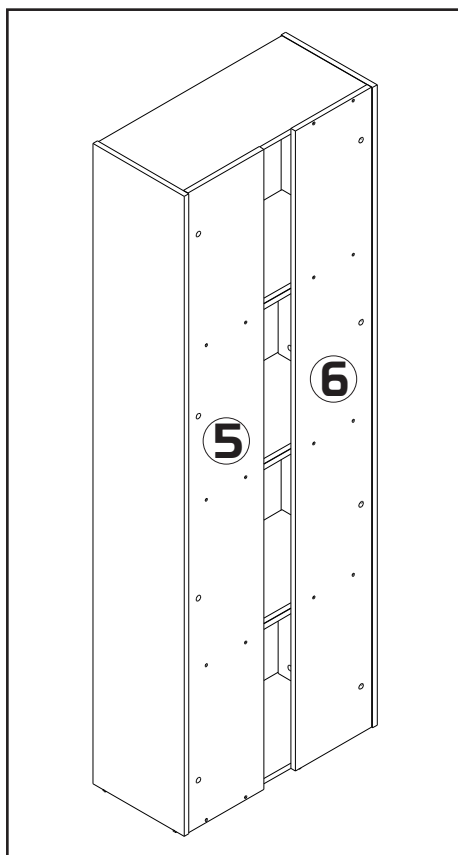

**Configuración
cerrada**

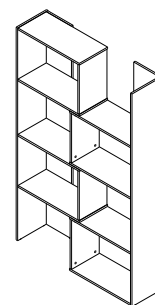

**Configuración
abierta**

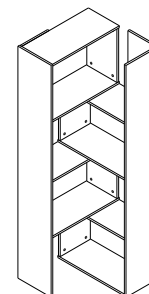

**Configuración
en esquina**

HERRAJES

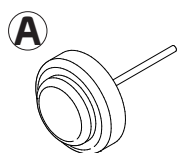

8 Und.
Deslizador
puntilla
20080011

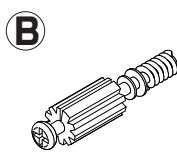

40 Und.
Perno minifix
0002715

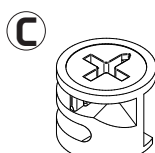

40 Und.
Tuerca minifix
0002715

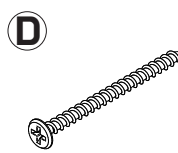

16 Und.
Tornillo 6x2"
0000152

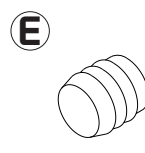

4 Und.
Mango M6x11
ext plastico
0004641

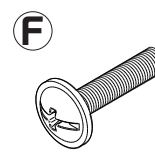

2 Und.
Tornillo M6x25
pan phi zinc
0004650

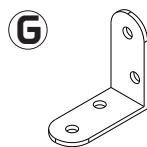

1 Und.
Cantонера 3
CND3818
0004644

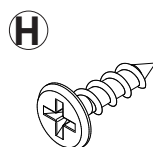

1 Und.
Tornillo 6x5/8"
ave phi zinc
0004705

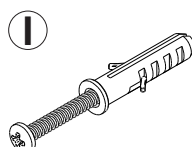

1 Und.
Juego tornillo 10x2"
chazo 5/16"
20020045

 **Practimac**
tu espacio, tu vida.

RECOMENDACIONES DE ENSAMBLE

Minifix

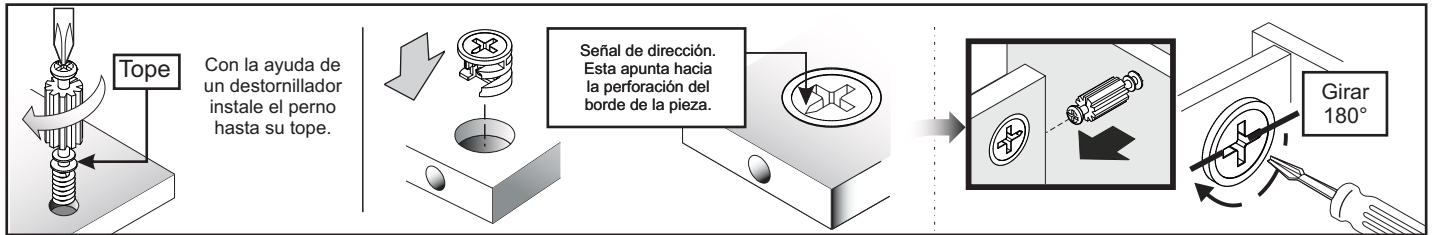

Nivelación de las puertas

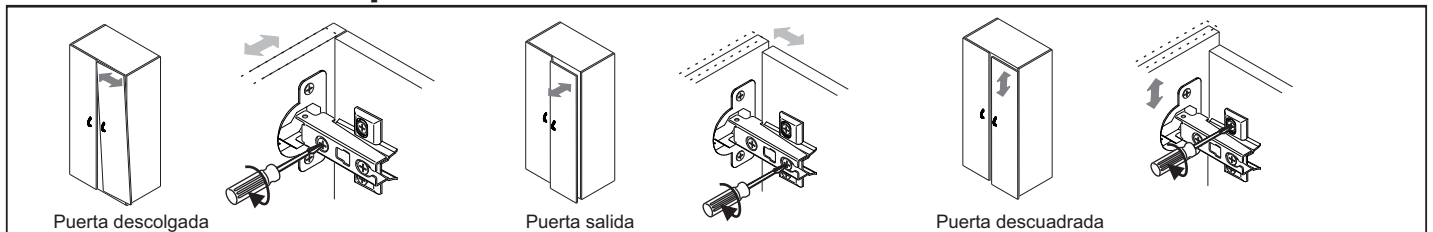

Tarugos

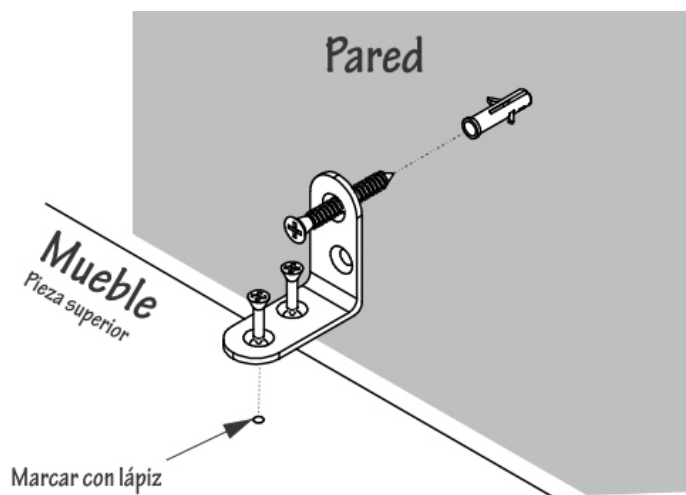
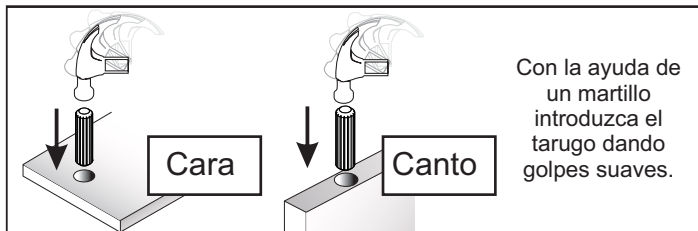

- Instale la cantonera al mueble con tornillos 6x5/8 ave phi zinc aglomerado.
- Ubique el mueble donde lo va a dejar.
- Marque con un lápiz la perforación del chazo en la pared.
- Quite el mueble,perfore con broca para pared de 5/16".
- Meta el chazo de 5/16".
- Nuevamente coloque el mueble,y asegúrelo a la pared con el tornillo de 10x2" ave phi zinc.

